

Montagehandleiding / Instruction manual / Mode d'emploi / Aufbauanleitung

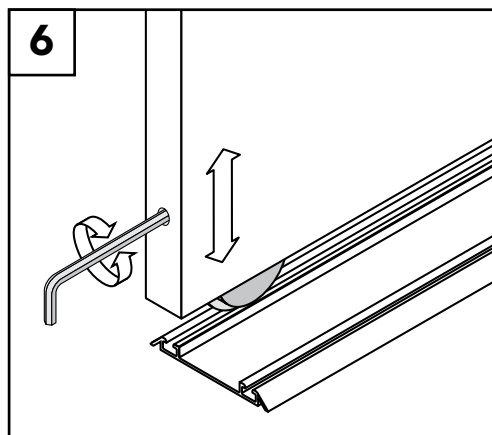

Voor het monteren van softclose op de deuren zie ommezijde.
 To assemble the softclose on style door see backside.
 Pour le montage du softclose voir ci-derrière.
 Für die Montage Softclose sehe Rückseite.

 = optioneel/option/Optional

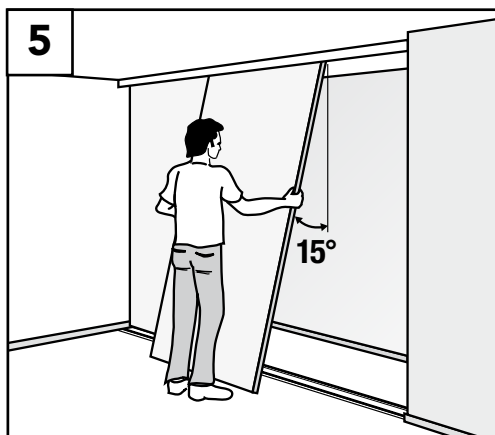
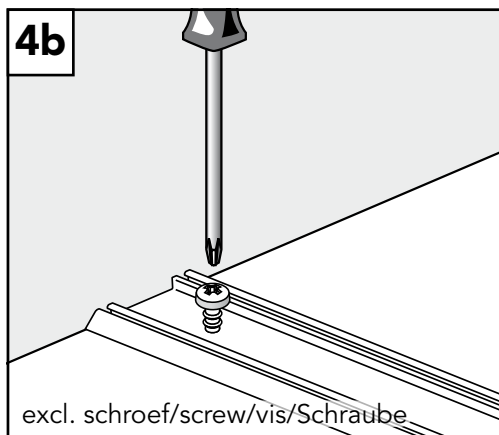
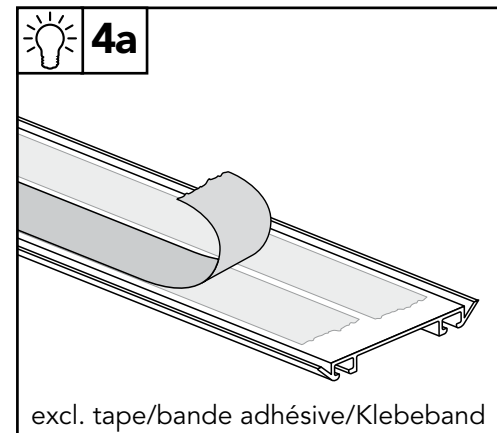
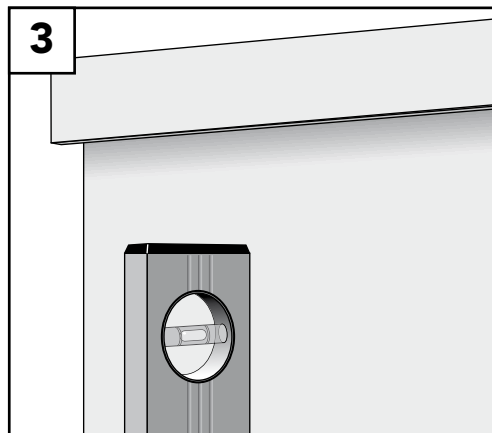
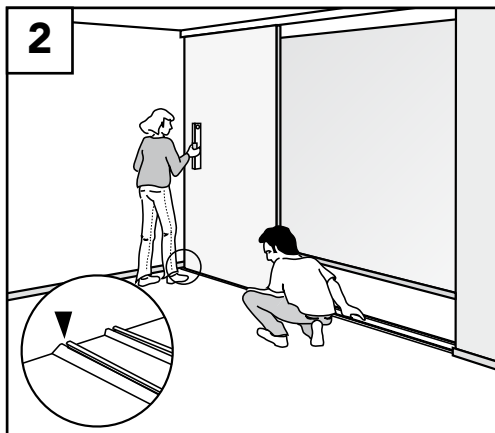
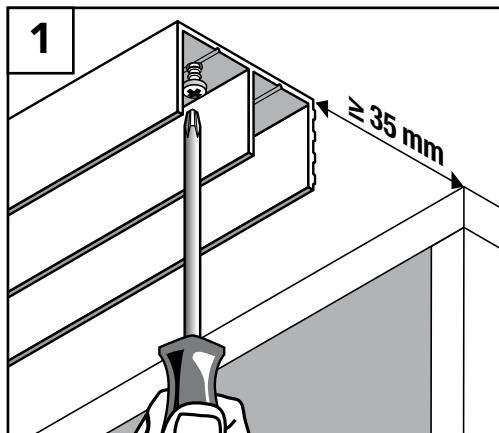
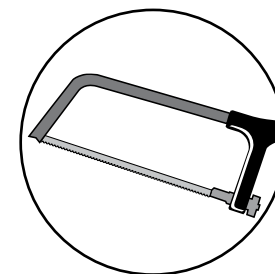
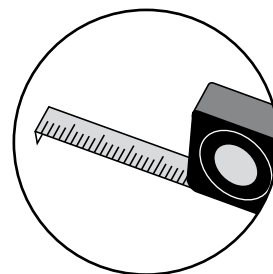
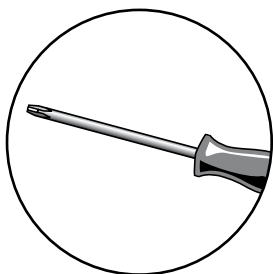
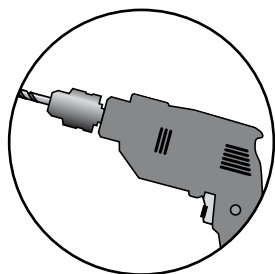
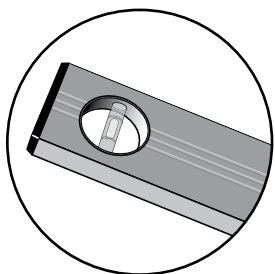

9 0 6 - 2 8 0 7 4

07-2024

Softclose

